**ARC2-NE****Description:**

The ARC2 Air/fuel Ratio Calibrator provides precise adjustment of the air/fuel ratio over the entire operating range of an internal combustion engine. It is especially useful for re-calibration of modified engines. The alteration or addition of turbochargers, superchargers, fuel injectors, fuel regulators, throttle bodies, intake plenums, Mass Air Flow (MAF) sensors or Manifold Absolute Pressure (MAP) sensors changes the air/fuel ratio. The ARC2 gives the user a convenient way to set the fuel mixture for rich, lean or stoichiometric operation over the entire RPM and load range.

The ARC2-NE is specifically designed for cases where the same style of air metering device as the stock device is used. One application for the ARC2-NE is conversion to a larger, less restrictive MAF sensor. Another application is for calibration of engines that have been converted to forced induction with a turbo or supercharger.

The ARC2 provides a means to achieve a best fit curved line approximation to the desired air/fuel calibration curve. It gives the user the ability to make these adjustments without a PROM change in the ECU. Furthermore, these adjustments can be made by the driver on-the-fly to optimize the air/fuel ratio for the current driving situation. The ARC2 also provides the ability to fine tune acceleration boost for optimum throttle response.

The ARC2 is typically used in conjunction with a precision air/fuel ratio meter such as the Split Second ARM1. The air/fuel ratio meter provides the required information needed to properly set the ARC2 front panel controls.

Features:

- Low load calibration (offset adjust)
- Mid load calibration (linearity adjust)
- High load calibration (gain adjust)
- Acceleration boost adjust
- Elevation compensation
- Output clamp (assures output is kept within ECU range)
- Filter to provide a smooth idle and optimum response
- Transient surge and battery reversal protection
- Automatic panel illumination dimming at night

Typical Connections:

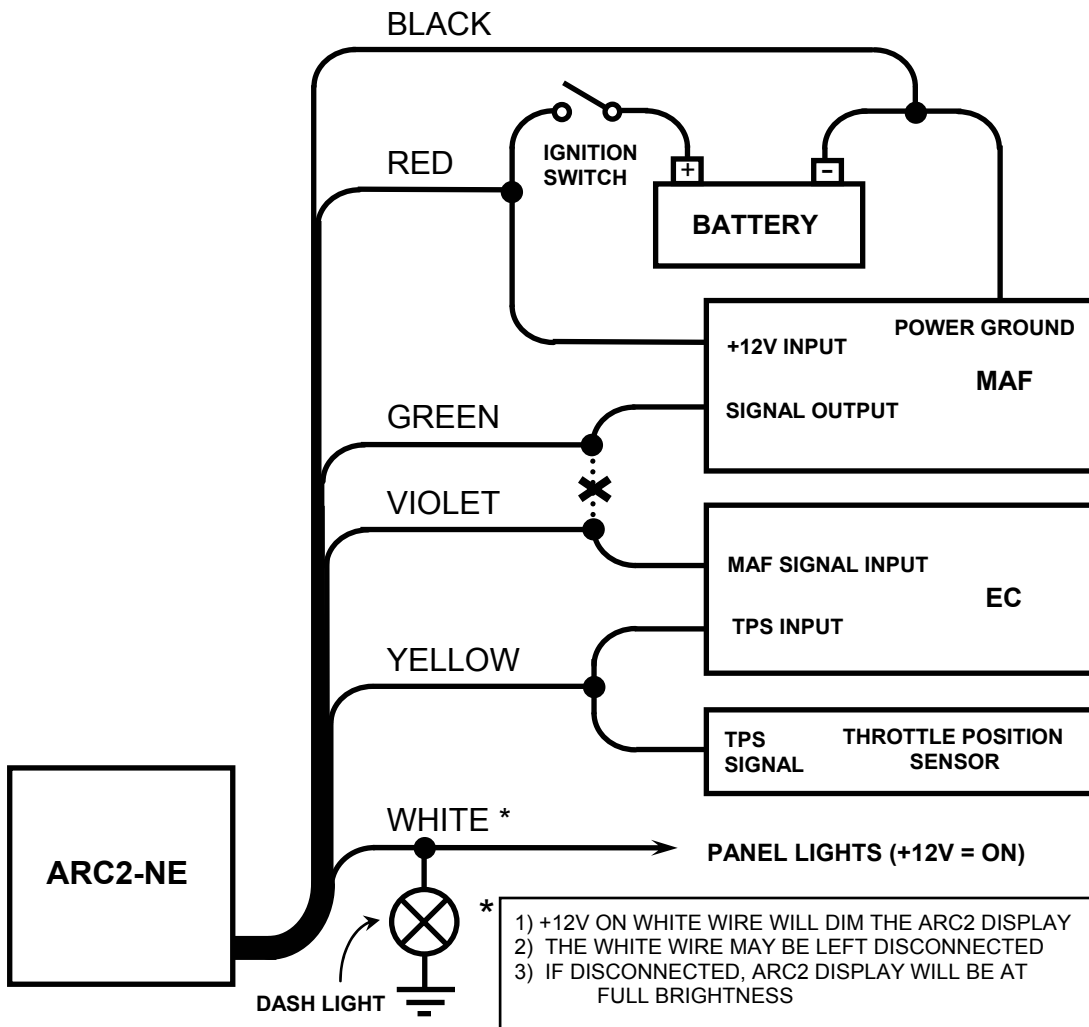

Front Panel Adjustments:

LOW

The LOW control adds a variable offset to the input signal. It therefore moves the output up or down (rich or lean) by a fixed amount over the entire operating range. The LOW control causes greater percentage changes at low load conditions. Idle and low speed cruise are low load conditions.

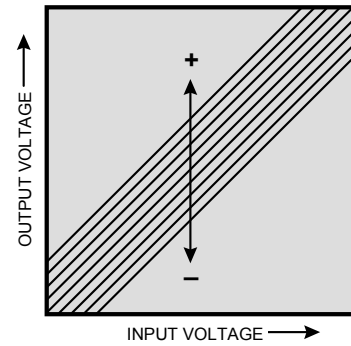

MID

The MID control alters the linearity of the input signal. Increasing the setting of the MID control bows the curve so that mid load values are boosted more than low and high load values. The MID control is used to fine tune the air/fuel ratio at moderate acceleration levels.

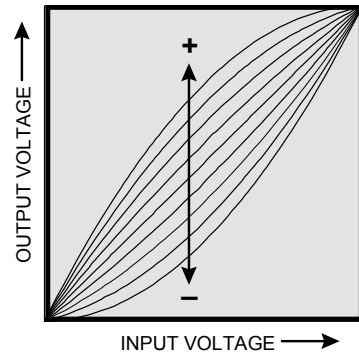

HIGH

The HIGH control changes the gain of the input signal. It therefore changes the output level by a fixed percentage over the entire operating range. Adjustment of the HIGH control is the primary way to control air/fuel ratio at high loads. High loads occur during full throttle acceleration and climbing steep grades.

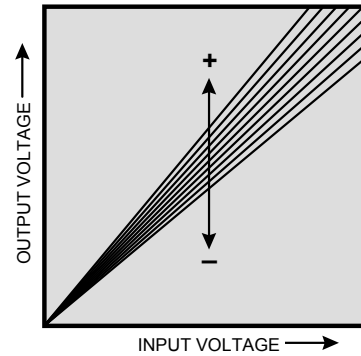

ACCEL

The ACCEL control momentarily makes the air/fuel ratio more rich. The degree of enrichment is related to the rate of change of the TPS input and the amount of boost selected by the ACCEL control. ACCEL boost is used to optimize throttle response.

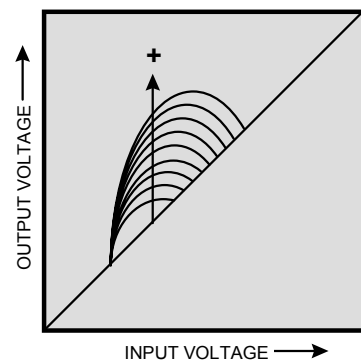

Adjustment Procedure:

Begin with the LOW, MID, HIGH and ACCEL controls set to zero. Use a precision air/fuel ratio meter such as the Split Second ARM1 to monitor the operating fuel mixture.

After starting the engine, adjust the LOW control for the desired air/fuel ratio at idle. Most engines are controlled by a closed loop system in the ECU which continuously adjusts the air/fuel ratio. When the system is operating normally, this can be observed as a back and forth sweeping of the reading on the ARM1. This sweeping action (or dithering) is a good indication of proper adjustment of the ARC2.

Allow the engine to warm up. Slowly rev the engine up to 3,000 RPM. Adjust the MID control for proper air/fuel ratio in the range from idle to 3,000 RPM. The controls on the ARC2 are somewhat interactive which may require that you go back and readjust the LOW setting. Once the LOW and MID controls are properly set, the car may be carefully driven. Use an isolated road that is free of traffic to complete the adjustments.

With the LOW and MID controls set, try some acceleration runs with increasing throttle settings. Adjust the HIGH control for proper air/fuel ratio under acceleration. Under heavy acceleration the ratio should be around 13.5:1 which corresponds to the first blue LED on the ARM1. The HIGH control will interact with the LOW and MID controls such that some adjustment of all three may be required to optimize performance over the full operating range.

The ACCEL control is used to improve throttle response. Blip the throttle and adjust the ACCEL setting until the engine revs cleanly in response to the throttle input. Do not set ACCEL higher than necessary for crisp throttle response. The ACCEL control will interact with the other controls. As the position of the ACCEL control is increased, the other controls may require readjustment.

Once the LOW, MID, HIGH and ACCEL controls are set properly, the fuel mixture can be adjusted for the entire load range of the engine by adjusting the high control up and down. For example, assume the engine has been set for stoichiometric operation over the full load range. If more power is desired, the fuel mixture can be made more rich by increasing the setting of the HIGH control. If better fuel economy is desired, the fuel mixture can be made more lean by decreasing the setting of the HIGH control.

Wire Assignments:

LABEL	CONNECT TO	WIRE COLOR
BATT+	Battery positive (+12V)	Red
BATT-	Battery negative (chassis ground)	Black
SIGI+	MAF signal output	Green
SIGO+	AFM signal input to the ECU	Violet
TPS	Throttle position switch signal for idle	Yellow
LIGHT	Instrument panel lighting (+12V = ON)	White

Electrical Characteristics:

PARAMETER	CONDITIONS	MIN	TYP	MAX	UNITS
Low Range	% adjust of full scale range	-20		20	%
Mid Range	% adjust of full scale range	-20		20	%
High Range	% adjust of full scale range	-20		20	%
Accel Range	% adjust of full scale range	0		20	%
Supply Voltage	BATT+ to BATT-	12	13.5	16	V
Input Voltage	SIGI to BATT-	0		5	V
Output Voltage	SIGO to BATT-	0		5	V
Dimming Voltage	LIGHT to BATT-	2	13.5	16	V
Input Resistance	SIGI to BATT-		100		k Ω
Output Resistance	SIGO to BATT-		100		Ω
Supply Current	BATT+ terminal (day)		90		mA
Supply Current	BATT+ terminal (night)		35		mA

Mechanical Characteristics:

Front View

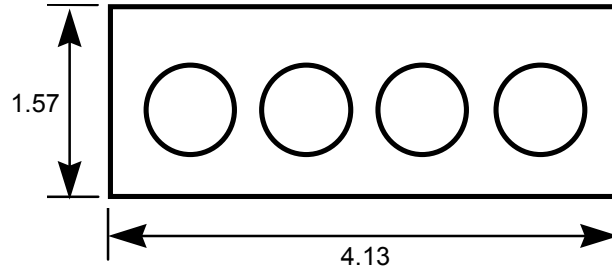

Side View

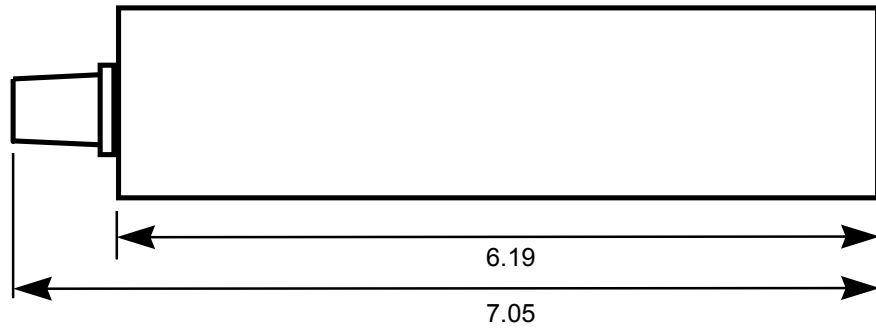

(dimensions in inches)



1949 E. Deere Ave.
Santa Ana, CA 92705
TEL (949) 863-1359
FAX (949) 863-1363